

Quest 105, 155, and 205 Dual

Installation, Operation and Maintenance Instructions

– Read and Save These Instructions –

This manual is provided to acquaint you with the dehumidifier so that installation, operation and maintenance can proceed successfully. Ultimate satisfaction depends on the quality of installation and a thorough understanding of this equipment. The dehumidifier is built around tested engineering principles and has passed a thorough inspection for quality of workmanship and function.

The **Quest 105 Dual** provides 105 pints per day of water removal at standard rating conditions (80°F/60%RH) while using only 4.9 amps/115V.

The **Quest 155 Dual** provides water removal of 155 pints per day at 80°F/60%RH using 8.0 amps/115V.

The **Quest 205 Dual** is the largest capacity of the group. This unit removes up to 205 pints of water per day using only 13.2 amps/115V and retains the same cabinet size as the 105 and the 155. Ideally suited for structures with high ceiling applications.



Features:

- Industry-leading efficiency, most efficient on the market today
- Plug-N-Play
- Patented, optimized air-to-air heat exchanger
- High-efficiency, long-life impeller fan
- Quiet operation and superior high static pressure performance
- Superior air filtration (MERV-11 standard)
- Patent Pending Dual air distribution
- Auto-restart after power outages
- Environmentally friendly R410A refrigerant

Water Removal Rates (Pints/Day)

105 pints	80°F, 60% (AHAM)	(105 Dual)
155 pints	80°F, 60% (AHAM)	(155 Dual)
205 pints	80°F, 60% (AHAM)	(205 Dual)



4201 Lien Rd
Madison, WI 53704
www.QuestProtect.com

Phone 608-237-8400
Toll-Free 1-800-533-7533
sales@QuestProtect.com

Table of Contents

Safety Precautions 3

1. Intended Application(s)..... 4

2. Registrations 4

3. Specifications 4

4 . Installation 4

 4.1 Location 5

 4.1A No Ducting 5

 4.1B Ducted Return and Supply 6

 4.1C Remote Area w/ Ducted Supply..... 6

 4.1D Remote Area w/ Ducted Return..... 7

 4.2 Electrical Requirements 7

 4.3 Condensate (Water) Removal 8

5. Ducting 8

 5.1 Supply Duct Kit 8

 5.2 Return Duct Kit..... 8

6. Operation 9

 6.1 Humidity Control Adjustment 9

 6.2 Blower (Fan) Switch 9

7. Maintenance 9

 7.1 Air Filter..... 10

8. Service 10

 8.1 Technical Description 10

 8.2 Troubleshooting 11

9. Service Parts List 12

10. Accessory/Replacement Parts List..... 12

11. Optional Remote Humidity Control..... 13

12. Wiring Diagram..... 14

Warranty 15



Safety Precautions

Read the installation, operation and maintenance instructions carefully before installing and operating this device. Proper adherence to these instructions is essential to obtain maximum benefit from your Quest *Dual* indoor air quality system.

READ AND SAVE THESE INSTRUCTIONS

- The device is designed to be installed **INDOORS IN A SPACE THAT IS PROTECTED FROM RAIN AND FLOODING.**
- Install the unit with space to access the back or side panels for maintenance and service. **DO NOT INSTALL UNIT WITH THE SERVICE PANELS INACCESSIBLE.**
- Avoid directing the discharge air at people, or over the water in pool areas.
- If used near a pool or spa; be certain there is **NO** chance the unit could fall into the water, be splashed and that it is plugged into a **GFI GROUND FAULT INTERRUPT OUTLET.**
- **DO NOT** use the device as a bench or table.
- **DO NOT** place the device directly on structural members. Provide vibration isolation in order to minimize operational vibration and/or noise.
- A drain pan **MUST** be placed under the unit if installed above a living area or above an area where water leakage could cause damage
- Never operate a unit with a damaged power cord. If the power cord is damaged it must be replaced by the manufacturer, its service agent, or similarly qualified person in order to avoid a hazard.
- The unit shall be installed in accordance with national wiring regulations.
- Do not obstruct the air intake and exhaust. Maintain a .3 m (1 ft) clearance around the air intake and exhaust.
- This appliance is not intended for use by persons (including children) with reduced physical, sensory or mental capabilities, or lack of experience and knowledge, unless they have been given supervision or instruction concerning use of the appliance by a person responsible for their safety. Children should be supervised to ensure that they do not play with the appliance.



1. Intended Application for Quest Dual

The Quest Dual is designed to operate in temperatures between 56° and 95°F.

In order to efficiently control humidity levels, the area in which the dehumidifier is to be operated must be free of water intrusion or excessive fresh (outside) air infiltration. Before installing the Quest Dual, water intrusion and air infiltration problems should be addressed or noted in calculations.

2. Registrations

The Quest Dual units conform to unified standard UL 60335-2-40.

3. Specifications

Unit:	4032270 105 Dual		4031490 155 Dual		4033060 205 Dual	
Blower: (Tested with duct collars on)	257 CFM @ 0.0" WG 206 CFM @ 0.2" WG 146 CFM @ 0.4" WG		391 CFM @ 0.0" WG 363 CFM @ 0.2" WG 337 CFM @ 0.4" WG		526 CFM @ 0.0" WG 495 CFM @ 0.2" WG 458 CFM @ 0.4" WG	
Power:	530 Watts @ 80°F and 60% RH		920 Watts @ 80°F and 60% RH		1525 Watts @ 80°F and 60% RH	
Supply voltage:	110-120 VAC - 1 Phase - 60 Hz.		110-120 VAC - 1 Phase - 60 Hz.		110-120 VAC - 1 Phase - 60 Hz.	
Current Draw:	4.9 Amps		8.0 Amps		13.2 Amps	
Energy Factor:	4.2 L/kWh		3.5		2.7	
Operating Temp:	56°F Min - 95°F Max		56°F Min - 95°F Max		56°F Min - 95°F Max	
Minimum Performance @ 80°F and 60% RH:						
Water Removal Efficiency:	105 Pints/Day 8.8 Pints/kWh		155 Pints/Day 7.3 Pints/kWh		205 Pints/Day 5.7 Pints/kWh	
Air Filter:	MERV-11 Size: 16" x 20" x 2"		MERV-11 Size: 16" x 20" x 2"		MERV-11 Size: 16" x 20" x 2"	
Power Cord:	10', 110-120 VAC, Ground		10', 110-120 VAC, Ground		10', 110-120 VAC, Ground *This unit requires a dedicated 20A circuit	
Drain Connection:	3/4" Threaded NPT		3/4" Threaded NPT		3/4" Threaded NPT	
Dimensions:	Unit	Shipping	Unit	Shipping	Unit	Shipping
Width:	20.25"	24"	20.25"	24"	20.25"	24"
Height:	21.75"	28.25"	21.75"	28.25"	21.75"	28.25"
Length:	38"	42"	38"	42"	38 "	42"
Weight:	140 lbs	160 lbs	140 lbs	160 lbs	150 lbs	170 lbs



4. Installation

4.1 Location

The Quest Dual can be installed in a variety of locations to meet the owner's needs; other considerations include:

1. Providing access to a 115 VAC power outlet (10' power cord is provided).
2. Locating near a floor or other suitable drain (8' drain hose included).
3. Mount 4" above drain.
4. Do not install the Quest Dual with the exhaust of the unit within 1' of a wall or obstruction. Do not place the unit near open water.

4.1A No Ducting (fig. 1)

The simplest installation is to place the Quest Dual with no ducting. To ensure optimal performance, the air inlet and the outlet of the unit must be at least 2' from walls and other obstructions to air flow. Recirculation of outlet air into inlet should be avoided as much as possible.

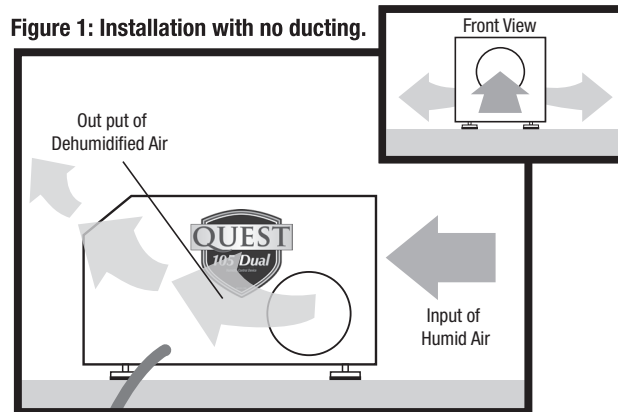

4.1B Ducted Return and Supply (fig. 2)

Dehumidification performance can be modified by adding an return and/or supply duct to circulate air. For optimal drying, use return duct to draw warm, moist air from near the ceiling.

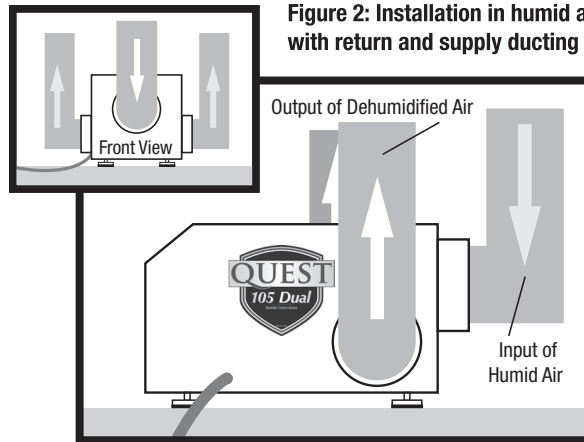
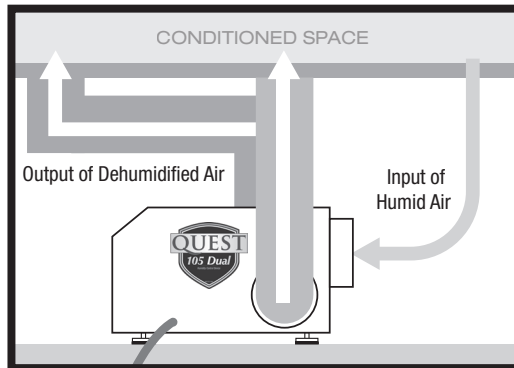

Figure 2: Installation in humid area with return and supply ducting

4.1C Remote Area, w/ Ducted Supply (fig. 3)

A simplified remote installation method than above uses ducting between the Quest Dual discharge and the humid room; the Quest Dual inlet draws air from the room in which it's located. This works well if there is an adequate air flow path between the two rooms; e.g. high door undercut, louvered door or wall grill. This eliminates the need to remote mount the humidity control.

Figure 3: Installation in a remote area with ducted supply only



⚠ WARNING! Before installing the dehumidifier in the manner described in section 4.1D (Fig. 4), call the factory for specific instructions if backdraft devices (i.e. hot waters heaters) are present in the space to be dehumidified.

4.1D In A Remote Area, Ducted Return Only (fig. 4)

When the Quest Dual is located in a room separate from the main area to be dehumidified, it may be desirable to dehumidify and/or slightly pressurize that room. Pressurization assures that open combustion devices do not backdraft. This can be prevented by installing a duct from the humid room to the Quest Dual inlet and by allowing the Quest Dual to discharge dehumidified air into the room in which it's located. An adequate air flow path must exist between the two rooms for this method to work properly.

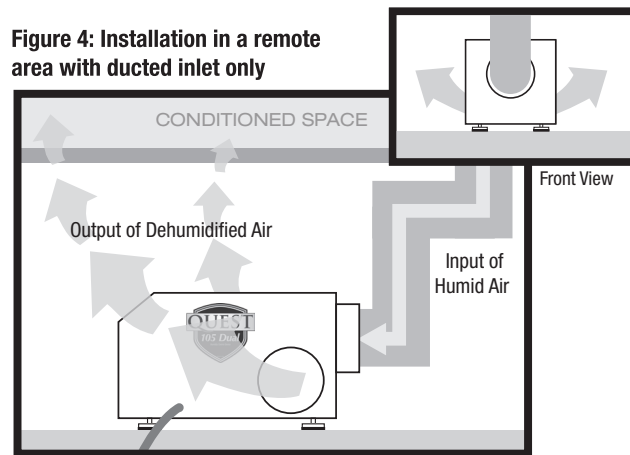

⚠ WARNING!

4.2 Electrical Requirements

The Quest Dual plugs into a common grounded outlet on a 110-120 VAC 15-Amp circuit. Use of a ground fault circuit interrupter (GFCI) protected circuit is recommended. The unit should not be used in areas prone to flooding.

⚠ CAUTION! For proper drainage, the unit must be mounted so the drain outlet is at least 4" above the floor drain, and must be fully supported under the base.

4.3 Condensate (Water) Removal

Condensate drains by gravity via the drain port. Use 3/4" male NPT PVC pipe. Route drain to drain. Install a trap if possible. Take care when installing drain pipe to drain port. Use an adjustable wrench to secure the drain port. An optional condensate pump kit (4028614) may be installed if a lift is required to dispose of the condensate. To order call 1-800-533-7533.

When installing the drain hose make sure the feet are extended such that the dehumidifier is 2 1/2" off the ground. Then coil the drain hose under itself or position a spacer to lift the hose 1" off the ground after the hose has touched the ground. This procedure will create a trap that ensures your unit drains correctly. See the diagram below for further visual clarification.

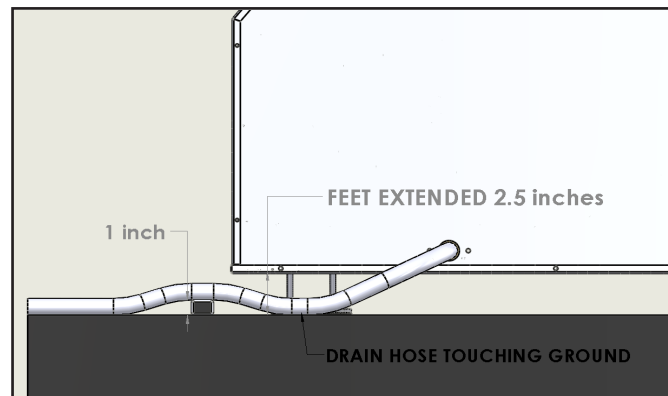

5. Ducting

5.1 Supply Duct Kit (P/N 4028607)

A factory designed supply duct kit can be purchased to accept 10" ducting to both outlets of the Quest Dual. Contact your dealer or call 1-800-533-7533 to order.

5.2 Return Duct Kit (P/N 4028610)

A factory designed return duct kit can be purchased to accept 12" ducting. Contact your dealer or call 1-800-533-7533 to order.

6. Operation

6.1 Humidity Control Adjustment

The humidity control is an adjustable switch that closes when the relative humidity of the air in which it is located rises to the dial set point. It opens when the RH drops 4 to 6% below the set point.

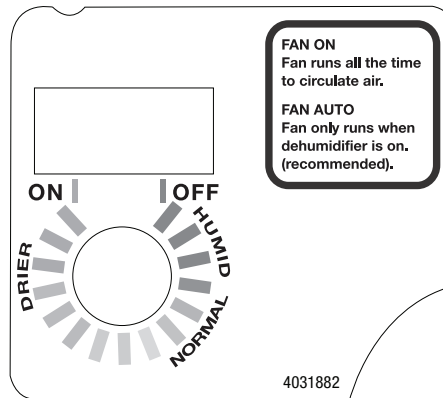

Approximate Humidity Levels Per Setting

- “Dry” 20% to 30% Relative Humidity
- “Normal” 50% Relative Humidity (Recommended)
- “Humid” 80% to 90% Relative Humidity

The dehumidifier will run until the relative humidity (RH) is reduced to the humidity control dial setting.

Quality humidity meters are available from the factory and are recommended to accurately monitor humidity levels. Contact your dealer or call 1-800-533-7533 to order.

6.2 Blower (Fan) Switch

Turning the blower switch to “**FAN ON**” will cause the unit’s internal blower to run continuously, whether the unit is dehumidifying or not. This function is desirable if the unit is used for air circulation.

Turning the blower switch to “**FAN AUTO**” will cause the unit’s internal blower to run only while the unit is dehumidifying.

7. Maintenance

⚠ WARNING! NOTE: Do not operate the unit without the filter or with a less effective filter. The heat exchange coils inside the unit could become clogged and require disassembly to clean.

7.1 Air Filter

The Quest Dual ships with a standard MERV 11 efficient pleated fabric filter. This should be checked every six months. The pleated fabric filter can generally be vacuumed clean several times before needing replacement. Operating the unit with a dirty filter will reduce dehumidifier capacity and efficiency and may cause the compressor to cycle on and off unnecessarily. Replacement filters can be ordered from your dealer or by calling 1-800-533-7533.

8. Service

⚠ WARNING! Servicing the Quest Dual with its high pressure refrigerant system and high voltage circuitry presents a health hazard which could result in death, serious bodily injury, and/or property damage. Only qualified service people should service this unit.

8.1 Technical Description

The Quest Dual uses a refrigeration system similar to an air conditioner's to remove heat and moisture from incoming air, and add heat to the air that is discharged. Hot, high pressure refrigerant gas is routed from the compressor to the condenser coil. The refrigerant is cooled and condensed by giving up its heat to the air that is about to be discharged from the unit. The refrigerant liquid then passes through a filter/drier and capillary tubing which cause the refrigerant pressure and temperature to drop. It next enters the evaporator coil where it absorbs heat from the incoming air and evaporates.

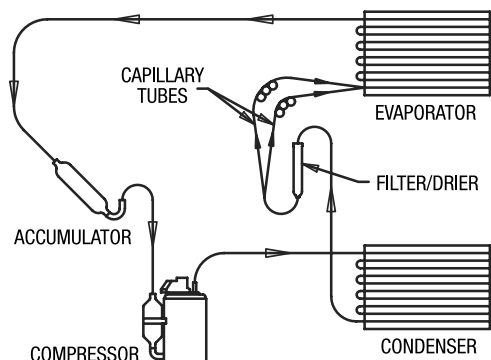

Quest Dual refrigeration system

The evaporator operates in a flooded condition, which means that all the evaporator tubes contain liquid refrigerant during normal operation. A flooded evaporator should maintain constant pressure and temperature across the entire coil, from inlet to outlet. The mixture of gas and liquid refrigerant enter the accumulator after leaving the evaporator coil. The accumulator prevents any liquid refrigerant from reaching the compressor. The compressor evacuates the cool refrigerant gas from the accumulator and compresses it to a high pressure and temperature gas to repeat the process.

8.2 Troubleshooting

FOR THE END USER:

If the unit does not work properly, please check the following:

- Is the unit unplugged?
- Is power to outlet on? (check switch, if applicable)
- Is circuit breaker tripped?
- Is humidity control set? (turn to “ON”)
- Is air flow restricted? (check air filter and grill)

If none of the above, call dealer or 1-800-533-7533.

FOR THE HVAC PROFESSIONAL:

No dehumidification. Neither blower, nor compressor run with fan switch AUTO.

1. Unit unplugged or no power to outlet, circuit breaker tripped.
2. Humidity control set to “Humid” setting.
3. Loose connection in internal wiring.
4. Humidity control is defective.

No dehumidification. Compressor does not run but blower runs with fan switch AUTO and humidity control turned to ON.

1. Defrost thermostat open, ambient temperature too low.
2. Loose connection in compressor circuit.
3. Defective compressor overload.
4. Defective compressor or compressor run capacitor.

Blower runs with fan switch AUTO but compressor cycles on & off.

1. Low ambient temperature and/or humidity causing unit to cycle through defrost mode.
2. Defrost thermostat defective.
3. Defective compressor overload.
4. Defective compressor.

- **Blower does not run with fan switch in either position. Compressor runs briefly but cycles on and off.**

1. Loose connection in blower circuit.
2. Obstruction prevents impeller rotation.
3. Defective blower.
4. Defective blower switch.

- **Evaporator coil frosted continuously, low dehumidifying capacity.**

1. Dirty air filter or air flow restricted.
2. Defrost thermostat loose or defective.
3. Low refrigerant charge.

If none of the above has fixed the issue, call technical support at 1-800-533-7533.

9. Service Parts List

Part No	Description	Part No	Description
4031086-02	Evaporator Coil E-Coat	4021469	(105, 155) Humidistat
4025741	(105, 155) Thermostat Defrost Control	4027172	(205) Humidistat
4032229	(205) Thermostat Defrost Control	4033031-02	(105) Blower Capacitor, Run, 5MFD, 370V
4032226	(105) Compressor Replacement Kit	4033031-07	(155) Blower Capacitor, Run, 15 MFD, 370V
4032225	(155) Compressor Replacement Kit	4033031-08	(205) Blower Capacitor, Run, 20 MFD, 370V
4032224	(205) Compressor Replacement Kit	4033032-03	(105) Compressor Capacitor, Run, 35 MFD, 370V
4029568	(105) Compressor Overload	4033032-05	(155, 205) Compressor Capacitor, Run, 45 MFD, 370V
4029714	(155) Compressor Overload		
4031574	(205) Compressor Overload		
4032196	(105) Impeller		
4026657	(155) Impeller		
4031089	(205) Impeller		

10. Accessory/Replacement Parts List

4021475	MERV 11 Filter (16"x20"x2")
4027420	MERV 11 Filters 4-Pack
4027424	MERV 11 Filters 12-Pack
4028614	Pump Kit
4028616	Caster Kit
4028607	Supply Duct Kit (includes two 10" collars)



4026969	10" Flex Duct 25'
4022126	10" Flex Insulated Duct 25'
4028610	Return Duct Kit (includes one 12" collar)
4024750	12" Flex Duct 25'
4028366	12" Flex Insulated Duct 25'
4020175	Remote Dehumidistat

**To order, contact your dealer
or call 1-800-533-7533.**

11. Quest Dual Optional Remote Humidity Control

⚠ CAUTION! This should only be performed by a qualified electrician.

A 120 VAC remote humidity control is available from the factory. This replaces the factory mounted humidity control on the cabinet of the dehumidifier, and allows you to accurately sense the humidity in an area other than the one where the dehumidifier is located.



4020175

12. Wiring Diagram

105, 155 Dual

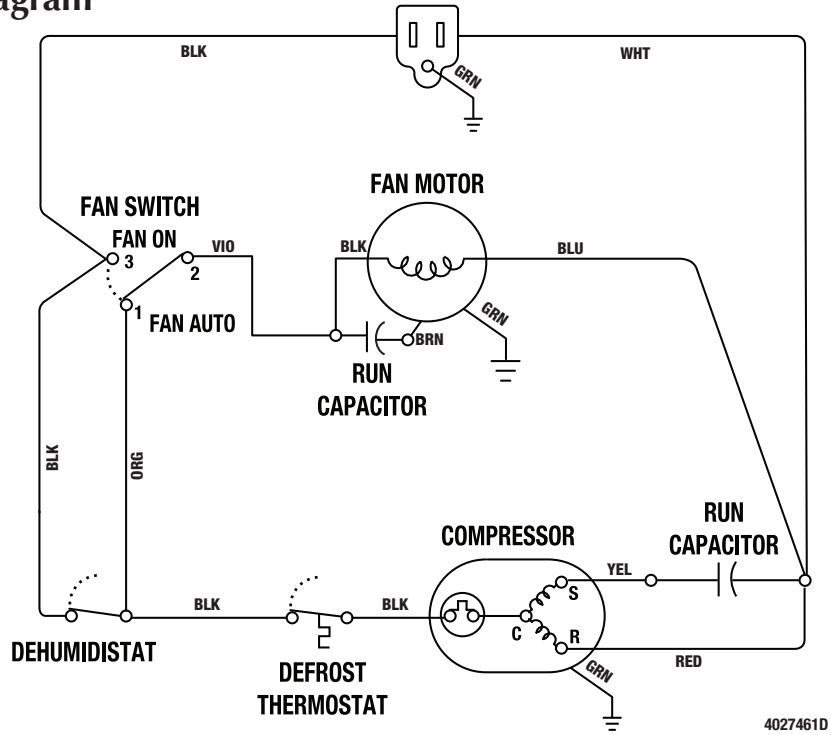

205 Dual

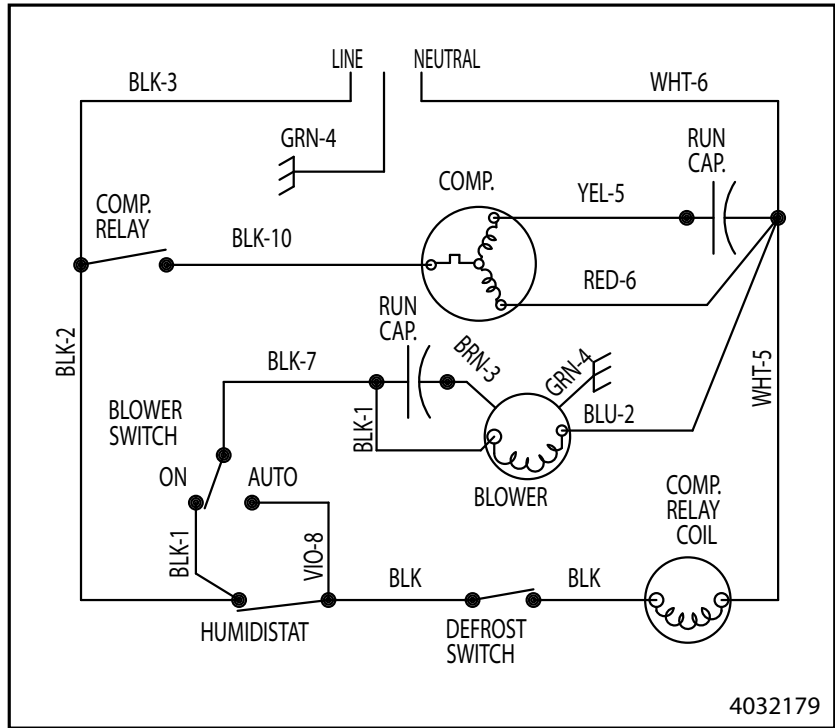

Quest Dual Dehumidifier Limited Warranty

WARRANTOR:

Therma-Stor LLC
4201 Lien Rd
Madison, WI 53704
Telephone: 1-800-533-7533

WHO IS COVERED: This warranty extends only to the original end-user of the Quest Dual dehumidifier, and may not be assigned or transferred.

FIRST YEAR WARRANTY: Therma-Stor LLC warrants that, for one (1) year the Quest Dual dehumidifier will operate free from any defects in materials and workmanship, or Therma-Stor LLC will, at its option, repair or replace the defective part(s), free of any charge.

SECOND THROUGH FIFTH YEAR WARRANTY: Therma-Stor LLC further warrants that for a period of five (5) years, the condenser, evaporator, and compressor of the Quest Dual dehumidifier will operate free of any defects in material or workmanship, or Therma-Stor LLC, at its option, will repair or replace the defective part(s), provided that all labor and transportation charges for the part(s) shall be borne by the end-user.

END-USER RESPONSIBILITIES: Warranty service must be performed by a Servicer authorized by Therma-Stor LLC. If the end-user is unable to locate or obtain warranty service from an authorized Servicer, he should call Therma-Stor LLC at the above number and ask for the Therma-Stor LLC Service Department, which will then arrange for covered warranty service. Warranty service will be performed during normal working hours.

The End-user must present proof of purchase (lease) upon request, by use of the warranty card or other reasonable and reliable means. The end-user is responsible for normal care. This warranty does not cover any defect, malfunction, etc. resulting from misuse, abuse, lack of normal care, corrosion, freezing, tampering, modification, unauthorized or improper repair or installation, accident, acts of nature or any other cause beyond Therma-Stor LLC's reasonable control.

LIMITATIONS AND EXCLUSIONS: If any Quest Dual Dehumidifier part is repaired or replaced, the new part shall be warranted for only the remainder of the original warranty period applicable thereto (but all warranty periods will be extended by the period of time, if any, that the Quest Dual Dehumidifier is out of service while awaiting covered warranty service).

UPON THE EXPIRATION OF THE WRITTEN WARRANTY APPLICABLE TO THE Quest Dual DEHUMIDIFIER OR ANY PART THEREOF, ALL OTHER WARRANTIES IMPLIED BY LAW, INCLUDING MERCHANTABILITY AND FITNESS FOR A PARTICULAR PURPOSE, SHALL ALSO EXPIRE. ALL WARRANTIES MADE BY THERMA-STOR LLC ARE SET FORTH HEREIN, AND NO CLAIM MAY BE MADE AGAINST THERMA-STOR LLC BASED ON ANY ORAL WARRANTY. IN NO EVENT SHALL THERMA-STOR LLC, IN CONNECTION WITH THE SALE, INSTALLATION, USE, REPAIR OR REPLACEMENT OF ANY Quest Dual DEHUMIDIFIER OR PART THEREOF BE LIABLE UNDER ANY LEGAL THEORY FOR ANY SPECIAL, INDIRECT OR CONSEQUENTIAL DAMAGES INCLUDING WITHOUT LIMITATION WATER DAMAGE (THE END-USER SHOULD TAKE PRECAUTIONS AGAINST SAME), LOST PROFITS, DELAY, OR LOSS OF USE OR DAMAGE TO ANY REAL OR PERSONAL PROPERTY.

Some states do not allow limitations on how long an implied warranty lasts, and some do not allow the exclusion or limitation of incidental or consequential damages, so one or both of these limitation may not apply to you.

LEGAL RIGHTS: This warranty gives you specific legal rights, and you may also have other rights which vary from state to state.

